

TOWER MODEL	T-50XXHD
TOWER CONSTRUCTION	2 25 FT SECTIONS
TOWER SECTIONS	2
NUMBER OF SECTION	D, E
LENGTH OF EACH SECTION	25 FT
MAXIMUM HEIGHT W/ MAST	50 FT
NESTED HEIGHT W/O MAST	25 FT 6 IN
WIDTH OF UNIT	26 IN
RAISING SYSTEM	WORM GEAR WINCH
TYPE OF BASE	T
APPROXIMATE WEIGHT	290 LBS
MAXIMUM PAY LOAD	300 LBS
MAXIMUM WIND LOAD	25 SQ. FT.
MAXIMUM WIND	70 MPH

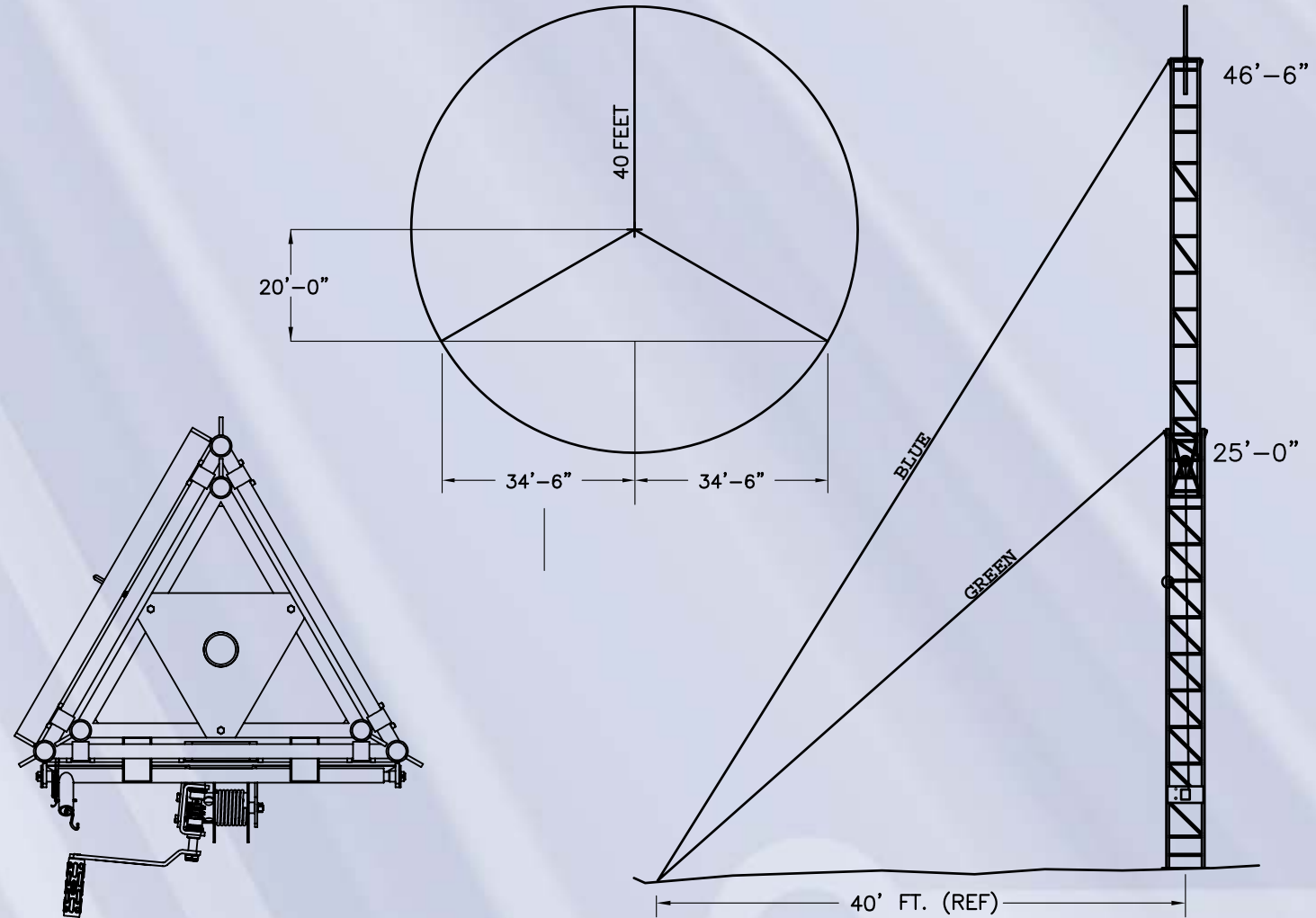
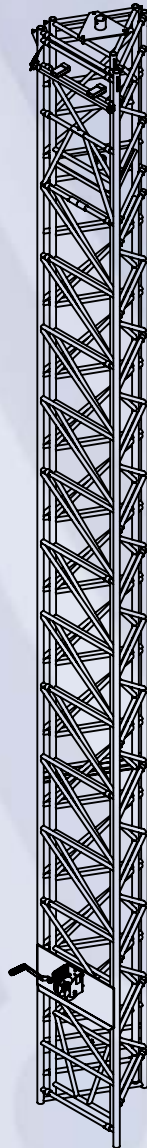

Not drawn to scale.
All Tower numbers are based on proper guyed installation conditions. See installation manual for directions.
Aluma Tower Company, Inc. reserves the right to make changes at any time to information contained in this document.