

TOWER MODEL	T-40HD
TOWER CONSTRUCTION	2 20 FT SECTIONS
NUMBER OF SECTION	2
TOWER SECTIONS	B, C
LENGTH OF EACH SECTION	20 FT
MAXIMUM HEIGHT W/ MAST	40 FT
NESTED HEIGHT W/O MAST	20 FT 6 IN
WIDTH OF UNIT	16 IN
RAISING SYSTEM	WORM GEAR WINCH
TYPE OF BASE	T
APPROXIMATE WEIGHT	88 LBS
MAXIMUM PAY LOAD	125 LBS
MAXIMUM WIND LOAD	18 SQ. FT.
MAXIMUM WIND	70 MPH

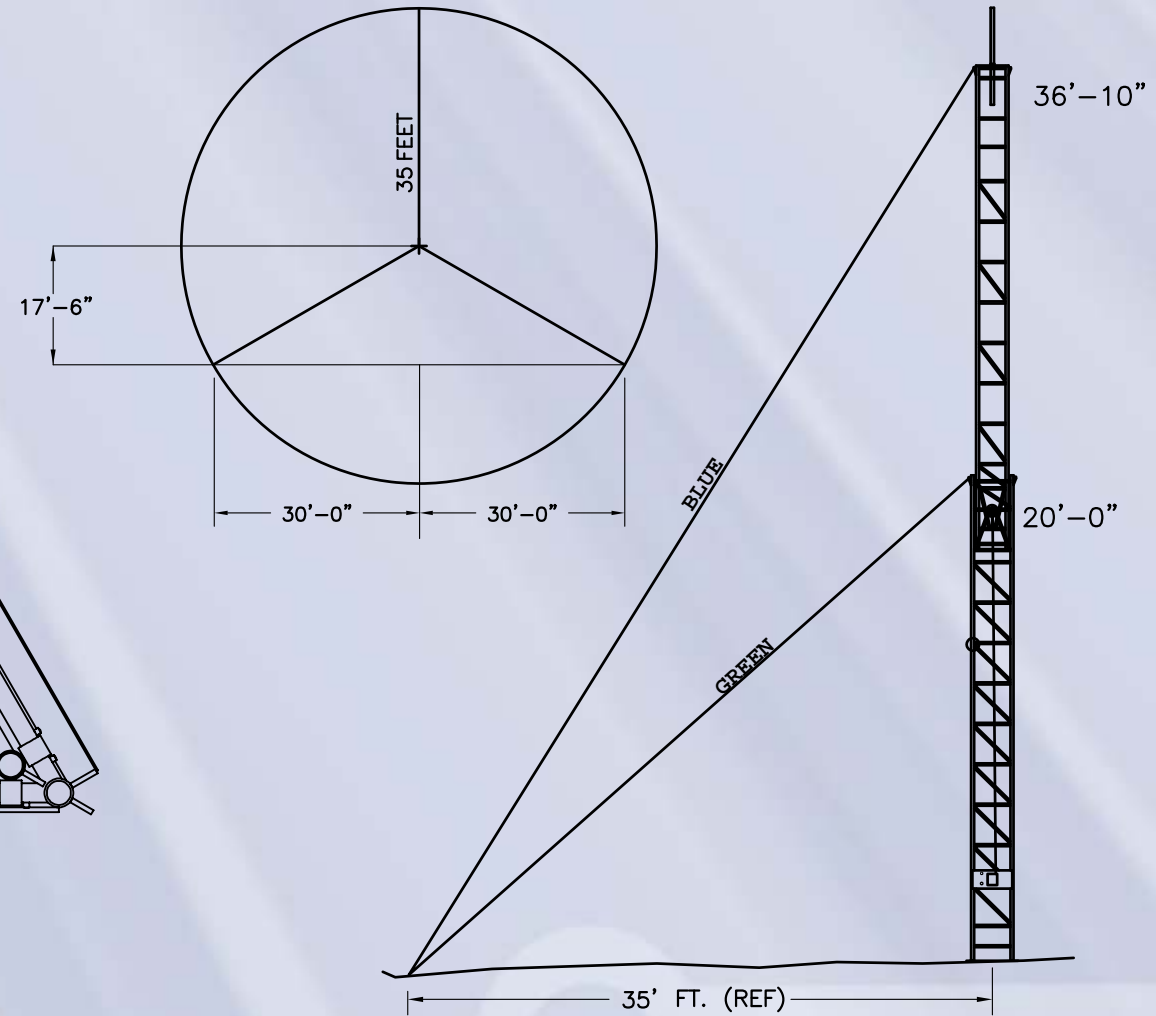
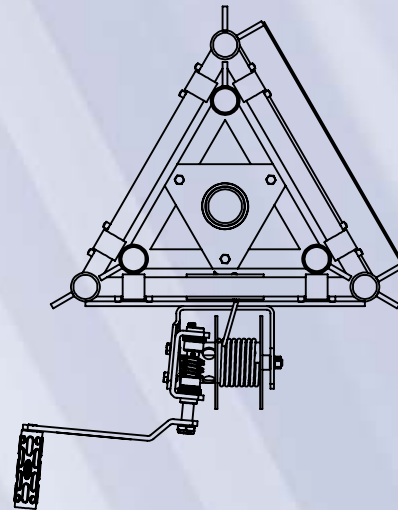
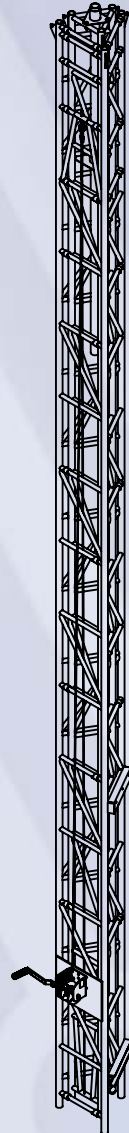

Not drawn to scale.
All Tower numbers are based on proper guyed installation conditions. See installation manual for directions.
Aluma Tower Company, Inc. reserves the right to make changes at any time to information contained in this document.